

toys · jouets · spielwaren
bruder

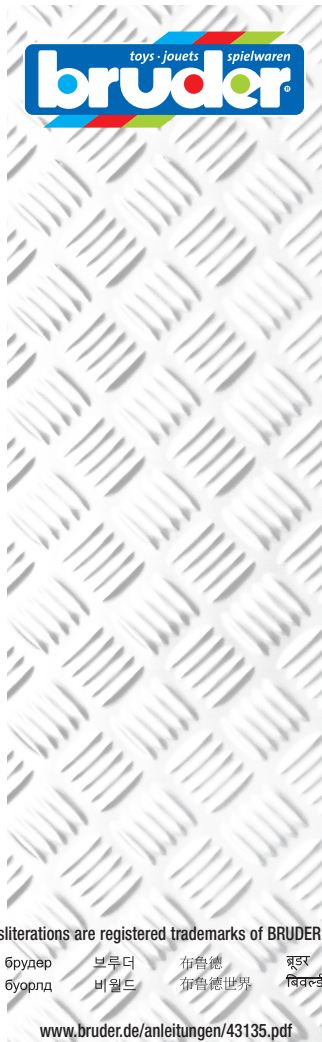

bruder, bworld and its transliterations are registered trademarks of BRUDER Spielwaren GmbH + Co. KG.

брудер	브루더	布鲁德	ब्रुडर
бурлд	비월드	布鲁德世界	बिर्वल्ड

www.brunder.de/anleitungen/43135.pdf

KBLB340

toys · jouets · spielwaren
bruder



43135



BRUDER Spielwaren GmbH + Co. KG
Postfach 190164 · 90730 Fürth/Germany

Telefon: + 49 (0)911 / 75209-230
Telefax: + 49 (0)911 / 75209-229

service@bruder.de
www.brunder.de

⚠ WARNING:
CHOKING HAZARD - Small parts
Not for children under 3 years

⚠ ATTENTION:
DANGER D'ÉTOUFFEMENT - petits éléments
Ne convient pas aux enfants de moins de 36 mois.

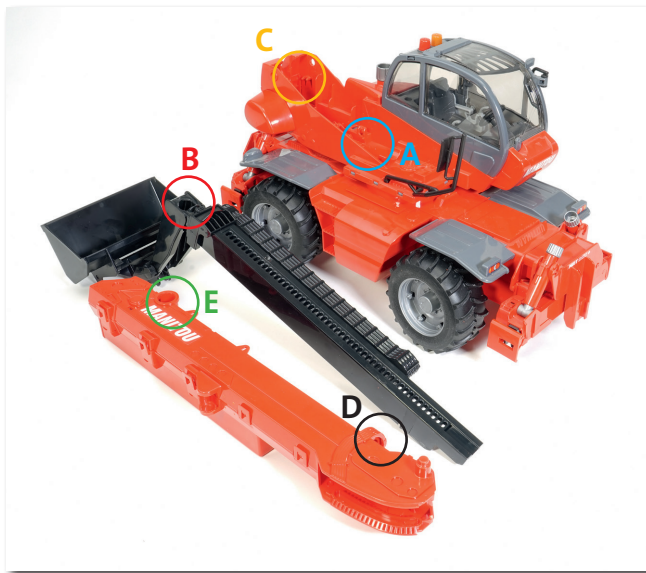
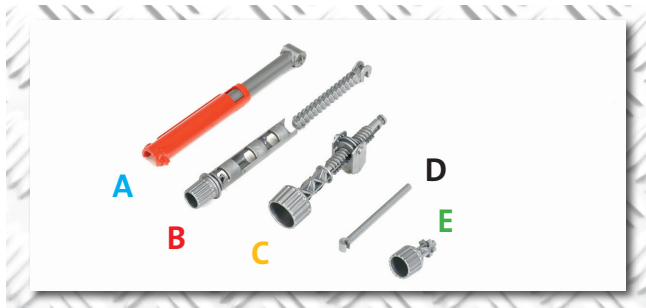

just like the real thing
Un grand reproduit en miniature

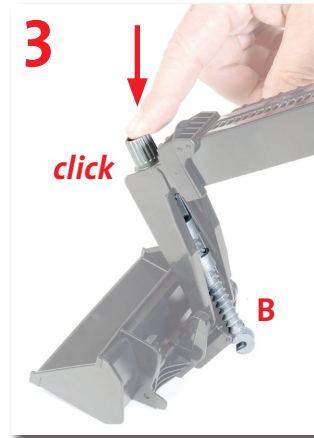
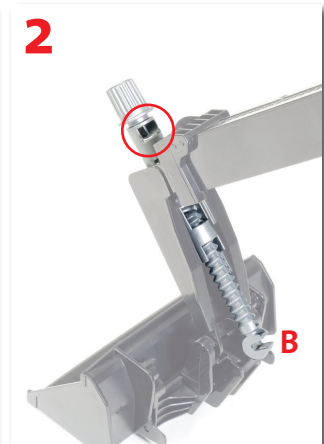
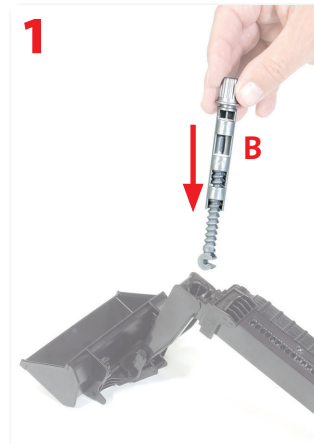

⚠ WARNING:
CHOKING HAZARD - Small parts
Not for children under 3 years

⚠ ATTENTION:
DANGER D'ÉTOUFFEMENT - petits éléments
Ne convient pas aux enfants de moins de 36 mois.

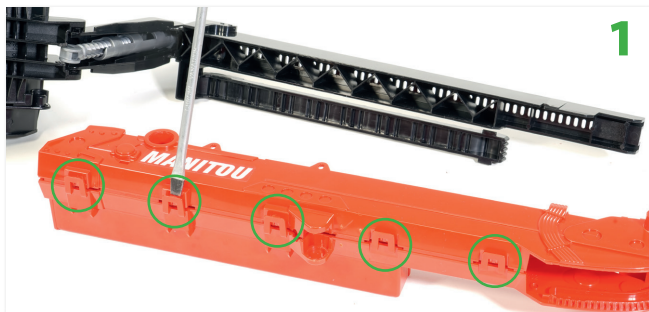

just like the real thing
Un grand reproduit en miniature

toys - jouets - spielwaren
bruder

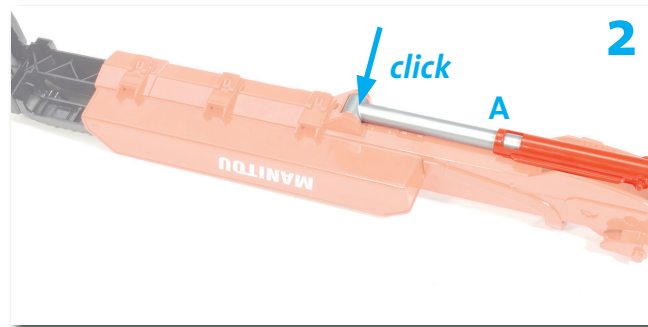
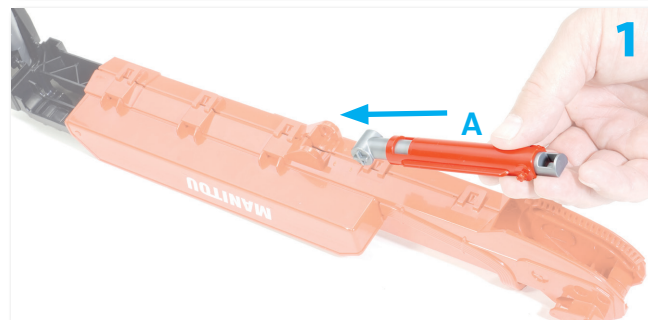
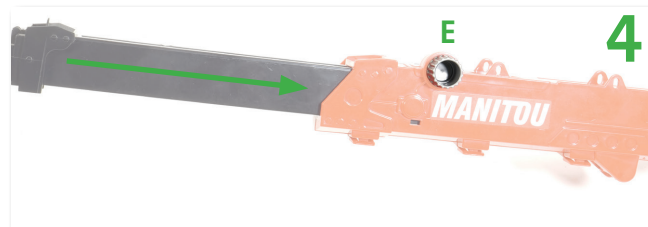

⚠ WARNING:
CHOKING HAZARD - Small parts
Not for children under 3 years

⚠ ATTENTION:
DANGER D'ÉTOUFFEMENT - petits éléments
Ne convient pas aux enfants de moins de 36 mois.

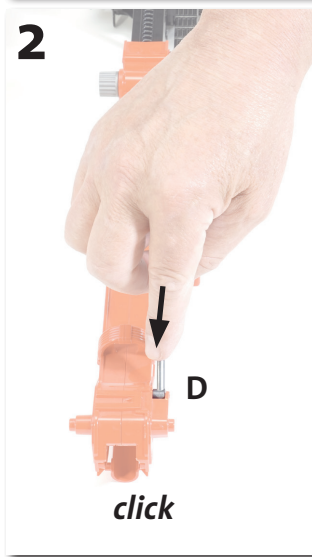
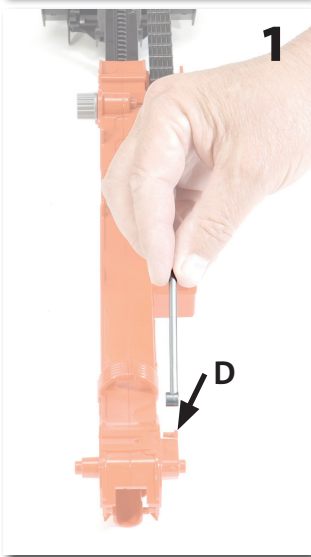
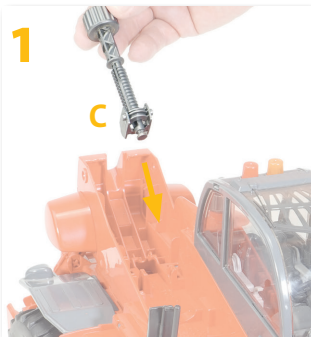

just like the real thing
Un grand reproduit en miniature

toys · jouets · spielwaren
bruder

